

Installation Instructions for **besgo** VALVES

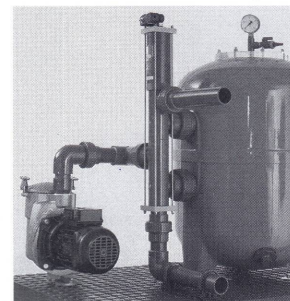

Installation of the automatic backwash system

All connections to the automatic backwash system can be glued outside (slip connections). The connections leading to the automatic backwash valve should be made using threaded connections or flanges (breakable couplings) and must be installed free from any tension.

Connections:

- A** Filter connection: top
- B** Filter connection: bottom
- C** Connection to filter pump
- D** Connection to backwash pipe
- E** Connection to return water pipe to pool

Maximum operating: (from pump)
pressure 3,5 bar

Please ensure that no adhesive gets inside the automatic backwash valve during installation. Incorrect installation can force the piston rod to jam and cause the valve to leak.

Fitting to the filter for DN40 / DN50 / DN65

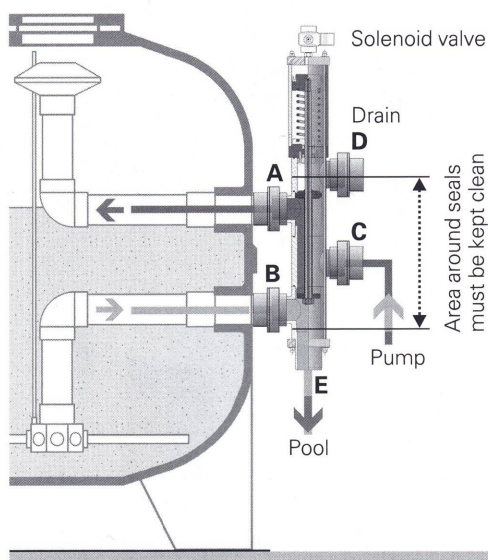

Mounting besgo on the Wall

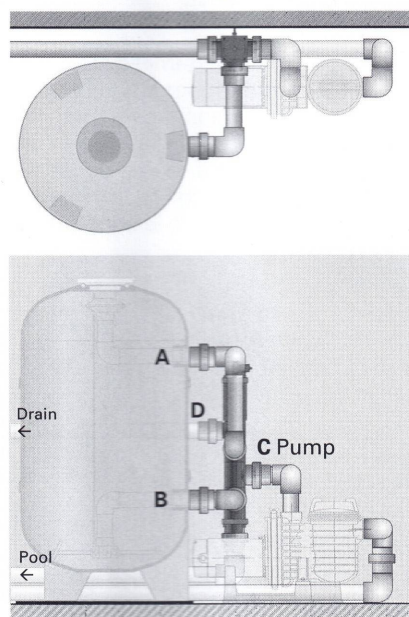

Besgo valves (DN65 / DN80 / DN100 / DN125) should be attached to the wall on site using pipe clamps.

Changing the direction of connections C and D

If the pipe work is not parallel to the unit, the connection unions **C** and **D** can be rotated through 90 degrees. Additionally a fine adjustment of $\pm 4^\circ$ is possible. This guarantees an installation free from any tension.

This is done as follows:

- a gently loosen the cap nuts on the four drawbars (Z).
- b unscrew one nut and lift the drawbar as high as possible.
- c rotate the corresponding connection pipe. **Attention!** Always remove only one drawbar. Replace drawbar and tighten nut gently. If necessary, adjust another drawbar and continue as stated above.
- d Fasten nut gently with a screwdriver, tightening diagonally, until any gap between both T-pieces disappears. Tighten nuts uniformly and ensure that the O-rings will not be jammed.

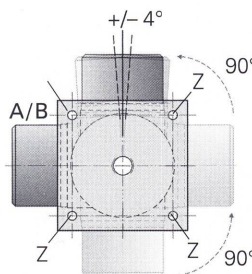

Possible Positions

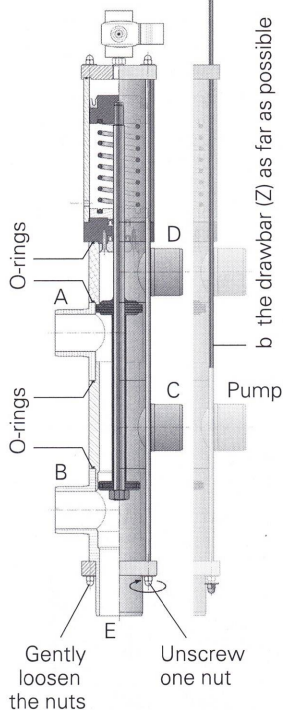
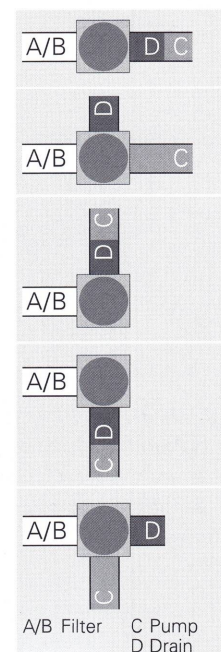

besgo
VALVES
- SIMPLE
- SAFE

Installation of the three way valve

■ Rinsing with additional 3-way valve

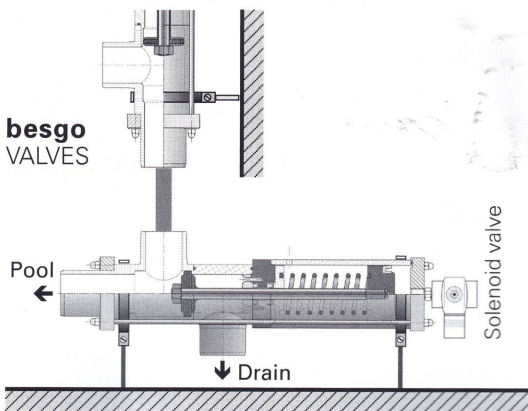

■ Energy saving

- 2 from main drain
- 4 pump
- 5 buffer tank
- 6 besgo 3-way valve
- 8 drain

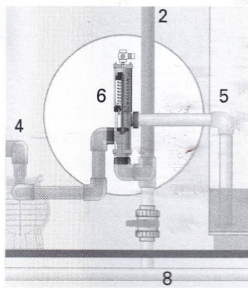

■ Switching between two water features

Switch over without switching off!

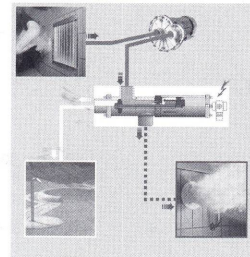

Only one pump and one inlet for two water features

■ Switching between pool and whirlpool

In order for the valves to close at the same speed, we recommend operation with compressed air

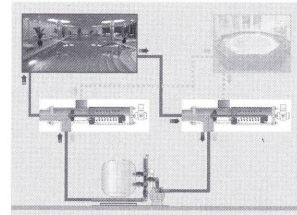

Only one filter, one pump, one water treatment
Switch over without switching off!

Connection of the Solenoid Valve

besgo VALVES are pneumatic valves. They can be operated with water or air pressure.

The operating pressure should lie between 3.5 - 6.0 bar.

Operation with water pressure (with pressure line PL, on site):

If the pressure of the water supply (mains pressure) is high enough, this pressure is totally suitable as the motive power needed to operate the valve. We recommend the **installation of a pre-filter** to protect the solenoid valve against dirt. A dirty solenoid valve can become blocked and this can lead to a malfunction.

If other devices (e.g. level controller) are connected to the same water circuit, a non-return valve must be fitted. When closing the valve, the water, which flows out from connection R1, can be channeled into the drain by means of a suitable tube. Please observe the regulations of your local water authority.

Operation with air pressure:

If the water pressure is too low, we recommend operation of the valves with air pressure. Small economical air compressors with tanks (min. 20 litre) are suitable. The valves operate considerably faster with air pressure than with water pressure.

Tip: The operation of the compressor can be limited to daytime hours by means of a time clock.

A practical tip

The non-return valve prevents pressure drop or suction if another device is connected to the same line.

For example:

whilst backwashing, the top-up of the overflow tank could be initiated. Without a non-return valve this could result in a pressure drop in the besgo valve which would cause the backwashing to stop immediately.

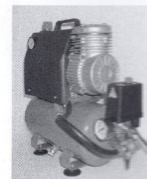

Compressor on site

Installation: DN40/d50, DN50/d63, DN65/d75, DN80/d90, DN100/d110, DN125/d140

Included is a 3/2-way solenoid valve (230 V) with emergency manual operation and 2 x 1/4" connections and 1 x 1/8" connection.

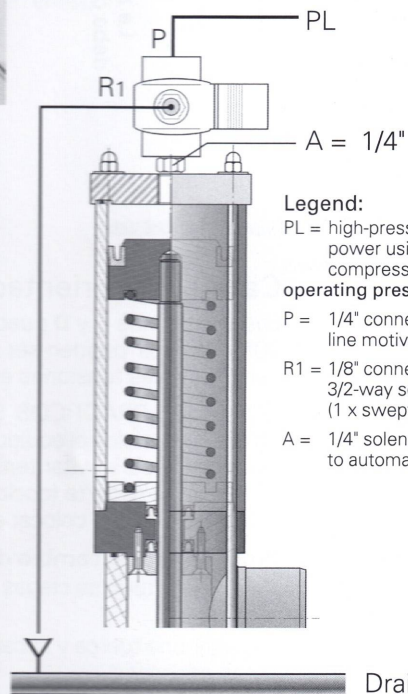
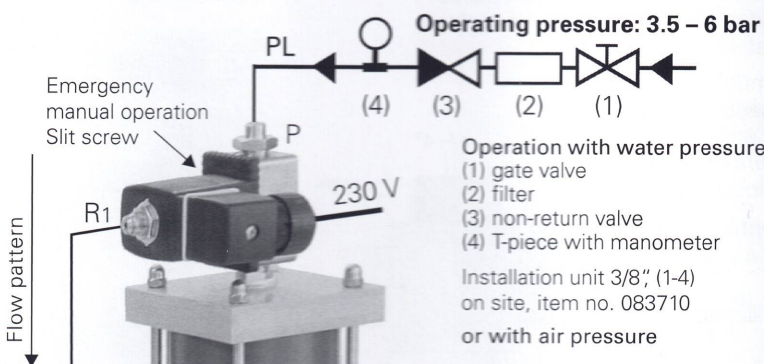

Legend:

PL = high-pressure line for motive power using mains water or compressed air:

operating pressure 3.5 - 6 bar

P = 1/4" connection for pressure line motive power

R1 = 1/8" connection for drain 3/2-way solenoid valve (1 x swept volume)

A = 1/4" solenoid valve connection to automatic backwash

Emergency manual operation

(for use by qualified service personnel only)

This is used for checking the correct operation of the besgo. Manual operation will trigger backwashing without automatic control. To initiate manual backwashing, the slotted screw must be turned 90° clockwise in the «backwashing».

The slit screw must be placed in the «Filter» position after backwashing, otherwise the pool will be emptied.

Slit screw «Filter» position

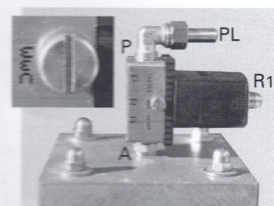

Slit screw «Backwash» position

